

CCS-300-1

FICHE TECHNIQUE / SPEC SHEET

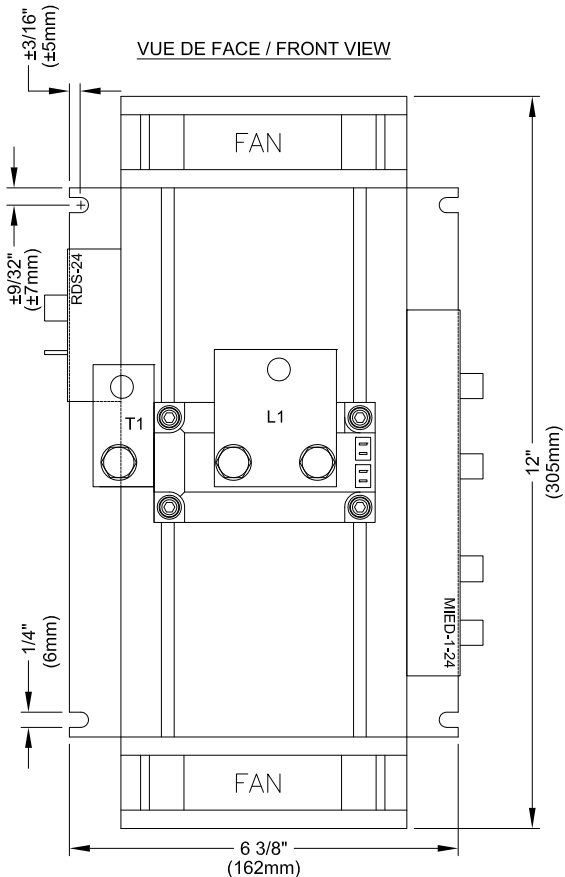

SPECIFICATIONS:

MODULES DE PUISSANCE / POWER MODULES : TYPE THYRISTORS
RADIATEUR / HEATSINK : TYPE 62905
VENTILATEUR / FAN : 110 CFM CHAQUE / EACH
ALIMENTATION REQUISE / REQUIRED SUPPLY : 24VAC
CONTRÔLE MODULANT / MODULATING CONTROL : MIED-1-24
SIGNAL DE CONTRÔLE / CONTROL SIGNAL : 0-5Vdc, 0-10Vdc, 0-135 ohms & 4-20mA

MODÈLE / MODEL : CCS-300-1
COURANT / AMPERAGE : 300A
VOLTAGE : 48VAC - 600VAC, 1 PHASE, 50-60 Hz
OPÉRATION PAR PASSAGE À ZÉRO / ZERO-CROSS OPERATION

NOTE: "LUGS" NON-INCLUS / LUGS NOT INCLUDED

↑
DIRECTION D'AIR / AIR FLOW

L1 = LIGNE / LINE
T1 = CHARGE / LOAD

VUE DE CÔTÉ / SIDE VIEW

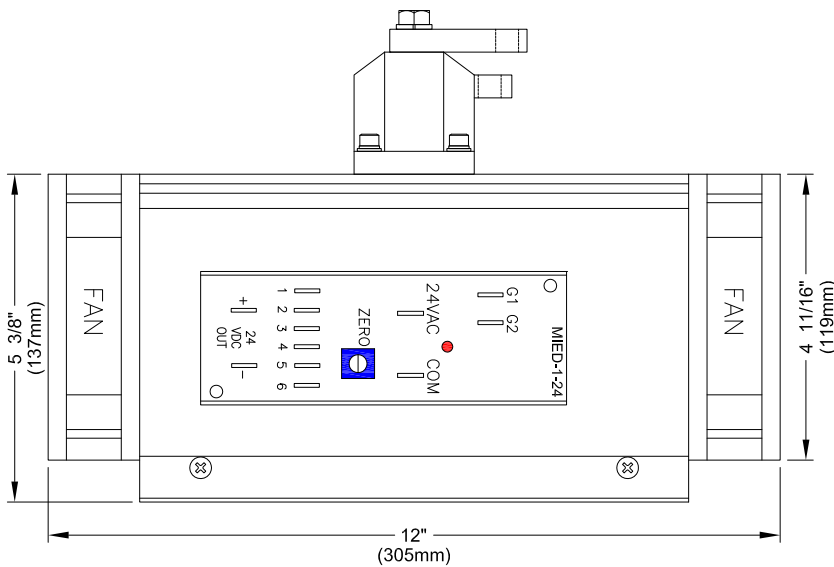

VUE DU BAS / BOTTOM VIEW

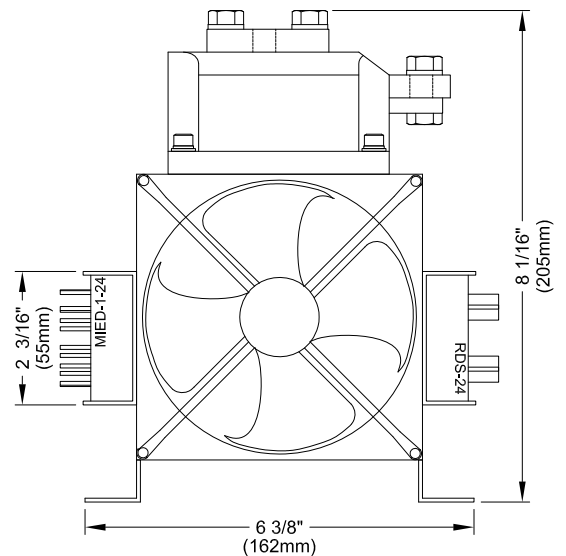

Configuration du signal de contrôle / Control signal configuration

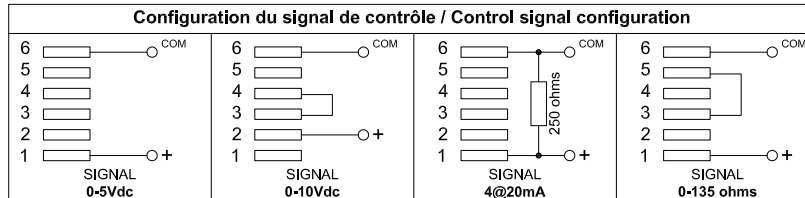

CRISTAL

2025 LAVOISIER #135
 QUEBEC, QC, CANADA
 G1N 4L6
 TEL: 1-800-681-9590
 FAX: 1-418-681-7393
www.cristalcontrols.com



C US
 CAN/CSA-C22.2 NO. 14-M95
 -APPAREILLAGE INDUSTRIEL DE COMMANDE
 UL Std No. 508
 -INDUSTRIAL CONTROL EQUIPMENT

- PROPOSITION
 - APPROBATION
 - INFORMATION
- Préparé par: LT, Vérifié par: PC

DESSIN / DRAWING :

CCS-300-1

DATE :

MARS 2012