

CCT-30-1

FICHE TECHNIQUE / SPEC SHEET

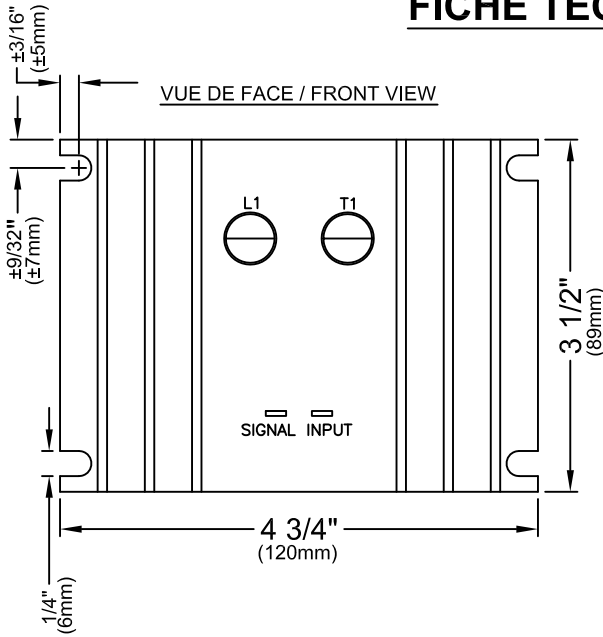

SPECIFICATIONS:

MODULE DE PUISSANCE / POWER MODULE : TYPE TRIAC

RADIATEUR / HEATSINK : TYPE MS-15170

SIGNAL DE CONTRÔLE / CONTROL SIGNAL : 3-32Vdc, 24Vdc, 24Vac

MODÈLE / MODEL : CCT-30-1

COURANT / AMPERAGE : 30A

VOLTAGE : 48 - 600VAC, 1 PHASE, 50-60 Hz

OPÉRATION PAR PASSAGE À ZÉRO / ZERO-CROSS OPERATION



DIRECTION D'AIR /
AIR FLOW

L1 = LIGNE / LINE
T1 = CHARGE / LOAD

VUE DE CÔTÉ / SIDE VIEW

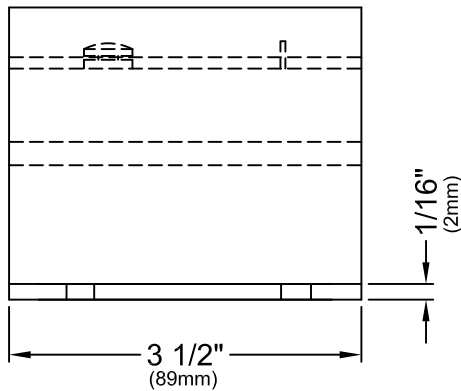

VUE DU BAS / BOTTOM VIEW

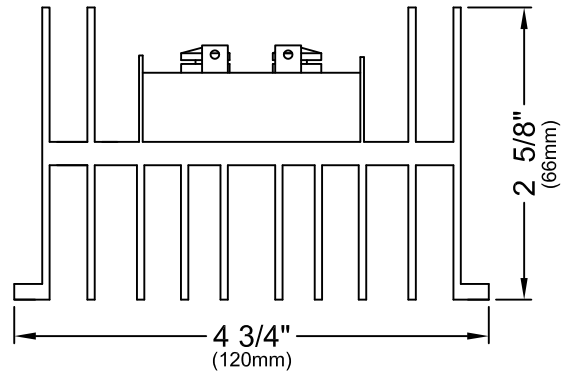

CRISTAL

2025 LAVOISIER #135
QUEBEC, QC, CANADA
G1N 4L6
TEL: 1-800-681-9590
FAX: 1-418-681-7393
www.cristalcontrols.com



CAN/CSA-C22.2 NO. 14-M95
-APPAREILLAGE INDUSTRIEL DE COMMANDE
UL Std No. 508
-INDUSTRIAL CONTROL EQUIPMENT

- PROPOSITION
- APPROBATION
- INFORMATION

Préparé par: LT, Vérifié par: PC

DESSIN / DRAWING :

CCT-30-1

DATE :

MARS 2012