

CCT-90-3Y

FICHE TECHNIQUE / SPEC SHEET

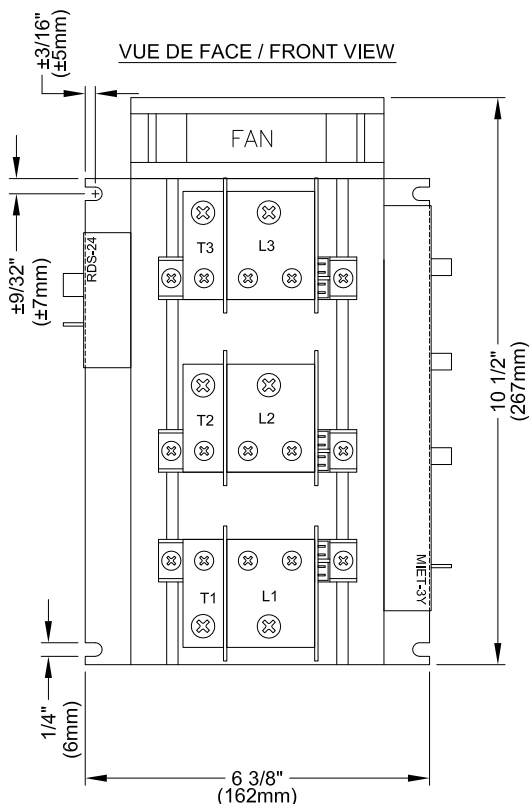

SPECIFICATIONS:

MODULES DE PUISSANCE / POWER MODULES : TYPE THYRISTORS
VENTILATEUR / FAN : 150 CFM
RADIATEUR / HEATSINK : TYPE 62905
ALIMENTATION REQUISE / REQUIRED SUPPLY : 24VAC
MODULE DE CONTRÔLE / CONTROL MODULE : MIET-3Y
SIGNAL DE CONTRÔLE / CONTROL SIGNAL : 3-32Vdc, 24Vac
MODÈLE / MODEL : CCT-90-3Y
COURANT / AMPERAGE : 90A
VOLTAGE : 48VAC @ 600VAC, 3 PHASES (3 LEGS)
OPÉRATION PAR PASSAGE À ZÉRO / ZERO-CROSS OPERATION



**DIRECTION D'AIR /
AIR FLOW**

L1, L2 & L3 = LIGNES / LINES
 T1, T2 & T3 = CHARGES / LOADS

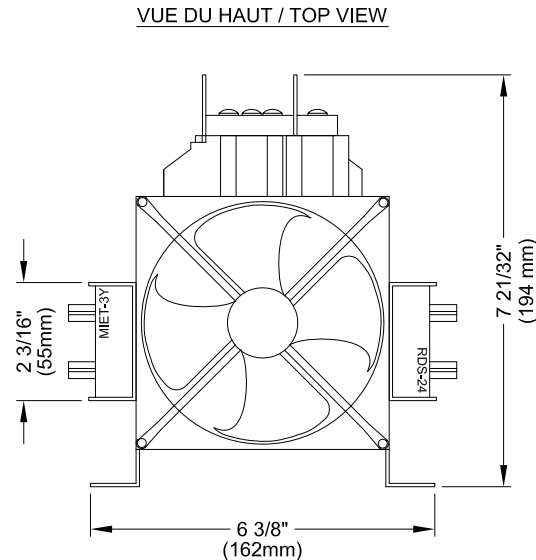
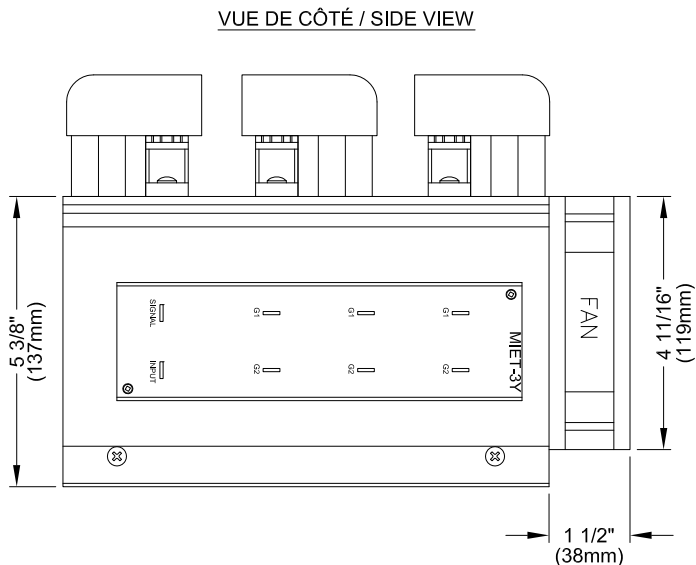

CRISTAL

2025 LAVOISIER #135
 QUEBEC, QC, CANADA
 G1N 4L6
 TEL: 1-800-681-9590
 FAX: 1-418-681-7393
www.cristalcontrols.com



C US
 CAN/CSA-C22.2 NO. 14-M95
 -APPAREILLAGE INDUSTRIEL DE COMMANDE
 UL Std No. 508
 -INDUSTRIAL CONTROL EQUIPMENT

- PROPOSITION
- APPROBATION
- INFORMATION

Préparé par: LT, Vérifié par: PC

DESSIN / DRAWING :

CCT-90-3Y

DATE :

MARS 2012